



Loop

TAILORMADE
STOCCO

Loop

Semplice. Elegante. Bella.

Simple. Elegant. Beautiful.

Simple. Élégant. Belle.

Eenvoudig. Elegant. Mooi.



Una cornice a rilievo disegna e racchiude il profilo del modulo contenitore sospeso. Si rincorre nelle colonne, nei vani a giorno, nei pensili creando un piacevole continuum.

Loop è una collezione di mobili sospesi dal disegno elegante e senza tempo, eppure nata da un pensiero al presente.

Le dimensioni sono studiate per offrire grande capacità contenitiva in due profondità ottimizzate per gli spazi abitativi d'oggi.

Loop

A relief frame draws and encloses the profile of the wall base unit. It runs through the columns, the open cabinets, the wall units, creating a pleasant continuity.

Loop is a collection of wall furniture with an elegant and timeless design, although born from a thought to the present. The dimensions are developed to offer a large containing capacity in two depths, optimized for today's living spaces.

Un cadre en relief dessine et entoure le profil des meubles suspendus. Il traverse les colonnes, les armoires ouvertes, les unités murales, créant une continuité agréable.

Loop est une collection de meubles suspendus avec une conception élégante et intemporelle, bien que née d'une pensée au présent. Les dimensions sont développées pour offrir une grande capacité contenante dans deux profondeurs optimisées pour les espaces de vie d'aujourd'hui.

Een lijst in reliëf tekent en omhult het profiel van het hangmeubel. Deze wordt herhaald in de kolomkasten, in de open rekken en in de hangkasten, wat een mooie continuïteit creëert.

Loop is een collectie hangmeubels met een elegant en tijdloos design, ondanks dat ze geboren is met het heden in gedachten. De afmetingen zijn bestudeerd om een maximum aan opbergruimte te bieden in twee verschillende dieptes, die speciaal berekend werden om tegemoet te komen aan de hedendaagse woonruimtes.





Il design contemporaneo incontra la bellezza senza tempo. Una lastra sottile in gres con una superficie materica hi-tech fa rivivere alcuni tra i più pregiati e ricercati marmi naturali.



Contemporary design meets timeless beauty. A thin slab of gres stoneware with a hi-tech material surface brings back to life some of the most prized and sought marbles.

Le design contemporain rencontre la beauté intemporelle. Une fine dalle en grès avec une surface en matériau de haute technologie fait revivre certains des marbres naturels les plus raffinés et les plus recherchés.

Het hedendaags ontwerp gaat hand in hand met een tijdloze schoonheid. Een dunne plaat in gres met een hi-tech oppervlakte doet enkele van de zeldzaamste en mooiste natuurlijke marmers herleven.



Loop si declina in diverse altezze, profondità e soluzioni contenitive. Ad esempio, le colonne: con una, due o più ante da affiancare e comporre.

Loop is declined in different heights, depths and storage solutions. For example, the columns: with one, two or more doors to be put side by side and be combined.

Loop est déclinée en différentes hauteurs, profondeurs et solutions de stockage. Par exemple, les colonnes : avec une, deux ou plusieurs portes à être côte à côte et combinées.

Loop bestaat in verschillende hoogtes, dieptes en opberguimtes. Bijvoorbeeld de kolomkasten: met één, twee of meer deuren om naast elkaar te plaatsen, dan wel te combineren.







Legno walnut. Top sottile in gres e ampio lavabo in appoggio. Armonia di materiali e proporzioni.



Loop

Walnut wood. Thin stoneware top and large sit-on washbasin. Harmony of materials and proportions.

Bois Walnut. Dessus en grès faible et vasque à poser grande. Harmonie des matériaux et des proportions.

Walnut hout. Blad in dun gres en een ruim opbouwwasbekken. Materialen en verhoudingen in harmonie.

Essenza di stile.

Ebano, il legno nobile per eccellenza, tra le essenze più iconiche del design, scopre un fascino contemporaneo nella finitura opaca abbinata al top in Corian.





Essence of style.

Ebony: the noble wood par excellence, among the most iconic essences of design, discovers a contemporary charm in the mat finish combined with the Corian top.

Essence de style.

Ébène: le bois noble par excellence, parmi les essences de design les plus emblématiques, découvre un charme contemporain dans la finition mate associée au plan en Corian.

De essentie van stijl.

Ebberhout: het nobele hout bij uitstek, behorend tot de meest iconische essenties in de designwereld, ontdekt een hedendaagse fascinatie in zijn matte afwerking, gecombineerd met een blad in Corian.









La base a giorno laterale in laccato Granata opaco crea un piacevole contrasto con il Rovere Safari.

Il sistema Loop comprende basi a giorno centrali, terminali frontali o laterali.

The Granata matt lacquered open side compartment creates a pleasant contrast with the Rovere Safari wood.

The Loop system includes central, front terminal or side open elements.

Le meuble a jour latéral laqué Granata mat crée un contraste agréable avec le bois Rovere Safari. Le système Loop comprend des éléments ouverts, centraux, terminaux frontaux ou latéraux.

De open onderkast aan de zijkant in mat gelakt Granata creëert een aangenaam contrast met de Safari Eik.

Het Loop-systeem biedt onderkasten in het midden, aan het uiteinde, aan de voor- en aan de zijkanten.









La finitura Rovere Termocotto ha uno charme particolare che parla di natura e di tecnologia.

Il legno, trattato ad alte temperature, assume tonalità più omogenee e un colore naturalmente più scuro.

La finitura spazzolata, protetta da vernice acrilica trasparente opaca esalta la venatura del legno con una piacevole texture tattile.

The Rovere Termocotto finish has a special charm that speaks about nature and technology.

The wood, treated at high temperatures, takes on more homogeneous tones and a naturally darker color.

The brushed finish, protected by opaque transparent acrylic paint, enhances the wood grain with a pleasant tactile texture.

La finition Rovere Termocotto a un charme particulier qui parle de nature et de technologie.

Le bois, traité à haute température, prend des teintes plus homogènes et une couleur naturellement plus foncée.

La finition brossée, protégée par une peinture acrylique transparente opaque, rehausse le grain du bois avec une texture tactile agréable.

De afwerking Thermo-behandelde Eik heeft een aparte charme die spreekt over natuur en technologie. Hout dat op hoge temperaturen behandeld is, neemt meer homogene kleurschakeringen aan, alsook een van nature donkerdere kleur.

De geborstelde afwerking, beschermd door een matte, transparante acrylische verf, doet de nerven van het hout maximaal tot hun recht komen, met een aangenaam gevoel op de tast.



La lavorazione precisa mette in risalto il design puro del sistema Loop.

The precise processing emphasizes the pure design of the Loop system.

Le traitement précis souligne la conception pure du système Loop.

De precieze afwerking doet het zuivere design van het Loop-systeem eer aan.





Finitura laccata lucida in colore Santorini. Una delle 58 scelte possibili nella cartella colori Loop.

Glossy lacquered finish in the color Santorini. One of 58 possible choices in the Loop color chart.

Finition laquée brillante de couleur Santorini. Un des 58 choix possibles dans le nuancier Loop.

Glanzende gelakte afwerking in de kleur Santorini. Eén van de 58 mogelijke keuzes uit het Loop-kleurenpalet.





Loop è un progetto rigoroso che esalta l'essenzialità della forma rettangolare. Tra le molte scelte possibili per il punto acqua, l'ampio lavabo Baia in Ceramilux crea un segno forte e distintivo.

Loop is a rigorous project that enhances the simplicity of the rectangular shape. Among the many possible choices for the water point, the large Baia washbasin in Ceramilux creates a strong and distinctive sign

Loop est un projet rigoureux qui exalte la simplicité de la forme rectangulaire. Parmi les nombreux choix possibles pour le point d'eau, la grande vasque Baia de Ceramilux crée un signe fort et distinctif.

Loop is een strak project dat de essentie van de rechthoek maximaal doet uitkomen. Uit de vele mogelijke keuzes voor het wasbekken, geeft het model Baia in Ceramilux een sterk en bijzonder teken.



Loop

Semplice. Elegante. Bella

Simple. Elegant. Beautiful.
Simple. Élégant. Belle.
Eenvoudig. Elegant. Mooi.



**Il sistema Loop permette ampia flessibilità di soluzioni.
Per i top è possibile scegliere tra 96 finiture diverse in differenti materiali.**

The Loop system allows great flexibility of solutions.
For the tops you can choose from 96 different finishes in different materials.

Le système Loop permet une grande flexibilité de solutions.
Pour les plans vasques vous pouvez choisir parmi 96 finitions différentes dans différents matériaux.

Het Loop-systeem biedt een ruime waaier aan oplossingen.
Voor het blad kan er gekozen worden uit 96 verschillende afwerkingen in verschillende materialen.





Acqua. Legno. Nuovi materiali.
In bagno c'è armonia.

Loop

Water. Wood. New materials.
In the bathroom there is harmony.

Eau. Bois. Nouveaux matériaux.
Dans la salle de bain il y a l'harmonie.

Water. Hout. Nieuwe materialen.
Er is harmonie in de badkamer.







Loop

Pensili e colonne

Hanging units and columns
Meubles hauts et colonnes
Hang- en kolomkasten



Modularità pensili e colonne

Modularity of hanging units and columns
 Modularité des meubles hauts et colonnes
 Samenstelbaarheid van hangkasten en kolomkasten.

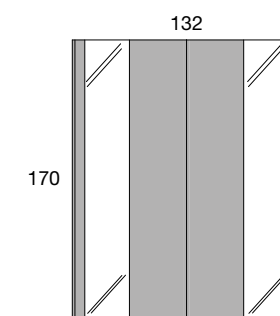
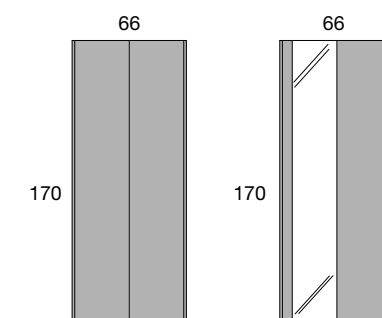
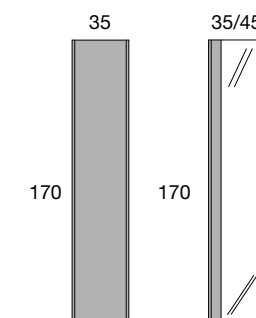
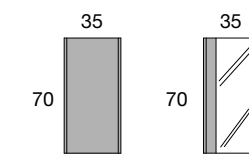
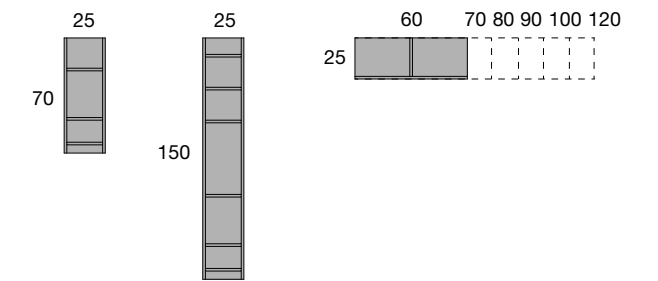



Le colonne hanno ante in laccato, legno o vetro con apertura premi-apri.
Nelle colonne a due ante è possibile scegliere la posizione delle ante in vetro.

The columns have lacquered, wood or glass doors with push-pull opening.
In the columns with two doors it is possible to choose the position of the glass doors.

Les colonnes ont des portes laquées, en bois ou en verre avec ouverture push-pull.
Dans les colonnes avec deux portes, il est possible de choisir la position des portes en verre.

De kolomkasten hebben gelakte deuren ofwel in hout of in glas met een druk-en opensysteem.
Voor de kolomkasten met twee deuren kan de plaats van de glazen deuren gekozen worden.





La proposta Loop si completa con colonne a giorno e mensole con divisorio fisso in varie larghezze.

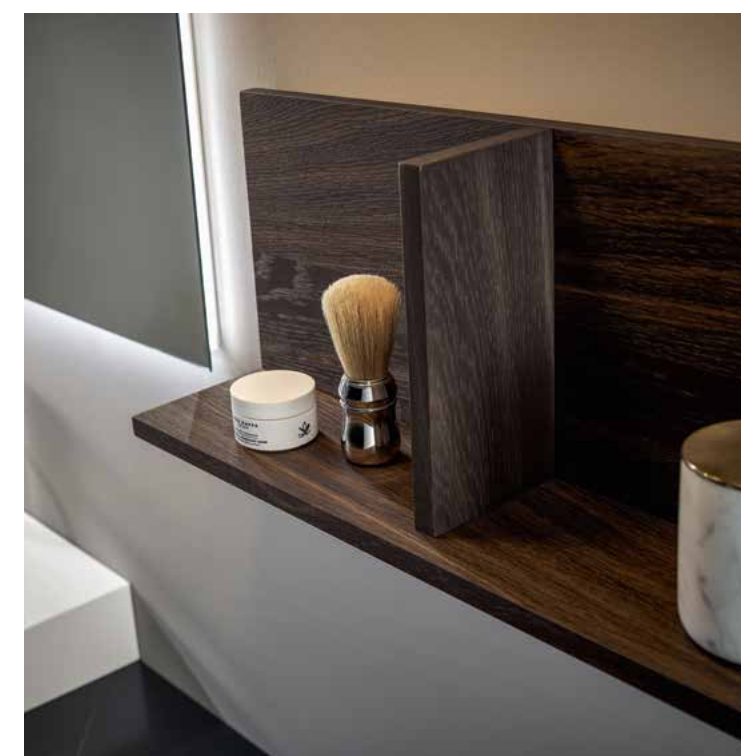

The Loop proposal is completed with open columns and shelves with fixed divider in various widths.

La proposition de Loop est complétée par des colonnes ouvertes et des étagères avec séparateur fixe de différentes largeurs.

De voorstellen van Loop worden vervolledigd met open kolomkasten en legplanken met een vaste scheiding, in verschillende breedtes.

Loop

Lavabi

Washbasins
Vasques
Wastafels

Per la gamma completa dei lavabi consultare il listino prezzi Tailormade Stocco/19.

For the complete range of washbasins, see the price list Tailormade Stocco/19.

Pour la gamme complète de vasques, voir la liste de prix Tailormade Stocco/19.

Voor het complete gamma wasbekkens, zie de prijslijst Tailormade Stocco/19.

TAILORMADE
STOCCO



Corian termoformato su misura

Thermoformed Corian on measure
Corian thermoformé sur mesure
Corian thermogevormd op maat



Corian termoformato applicato su misura

Applied thermoformed Corian on measure
Corian thermoformé rapporté sur mesure
Corian thermogevormd aangebracht op maat

Corian su misura

Corian on measure
Corian sur mesure
Corian op maat



Mineralmarmo



Cliff



Wave

HPL



Fenix





Ceramilux
Baia



Mineralmarmo



Free



Free



Quadro



Quadro



Quadro



Bowl



Ceramilux
Loop

Ceramica



Lux



Lux



Lux



Lux

Ceramilux



Tao



Garda



Lario

Loop

Com'è realizzato / How it is made / En detail / hoe wordt het gemaakt

- ① MOBILE disponibile in due profondità: 46 cm e 53 cm.
- ② Fianchi di finitura realizzati con pannelli in MDF Classe E1, W100 completamente laccati per le finiture O, B, con pannelli in melamminico Classe E1, W100 impiallacciati nelle finiture legno
- ③ Frontali apertura con maniglia, realizzati con pannello in MDF Classe E1 nelle finiture laccate O, B, oppure con pannelli in melamminico Classe E1, W100 impiallacciati nelle finiture legno
- ④ Struttura interna realizzata con pannelli in melamminico Classe E1, W100 colore grigio antracite
- ⑤ Cassetti in metallo verniciato con sponde in vetro
- ⑥ Installazione a muro con attacchi a parete regolabili, barre strutturali in alluminio utilizzabili come sistema antisgancio.

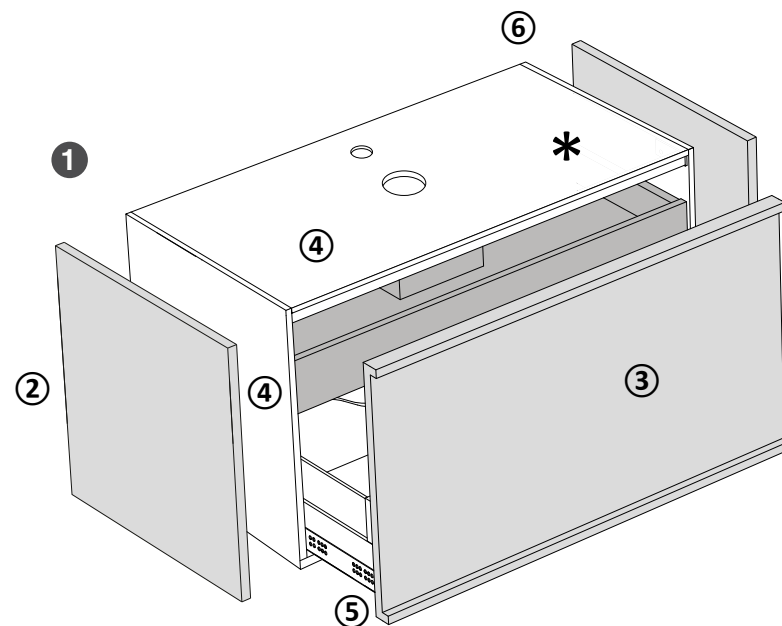
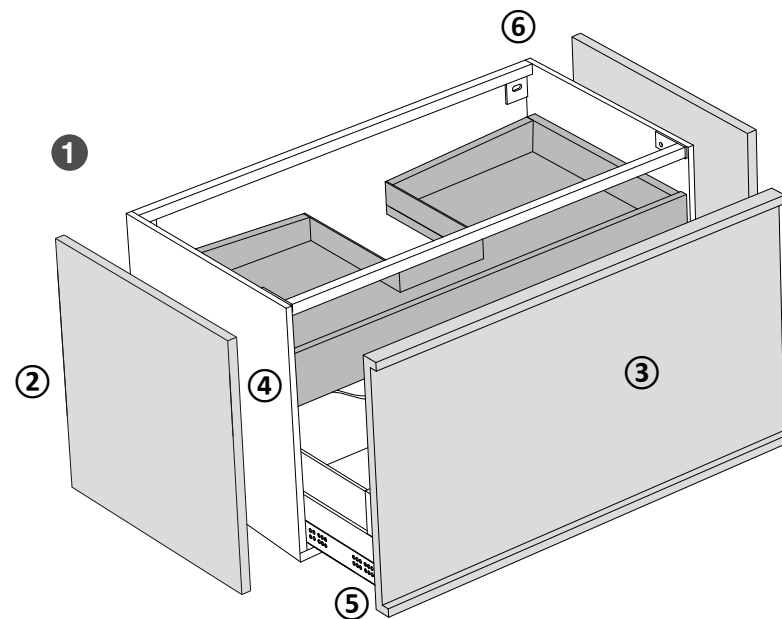

- ① BASE UNIT available in two depths: 46 cm and 53 cm.

② Finishing sides made with MDF panels Class E1, W100, completely lacquered for the finishes O, B. Sides made with veneered melamine Class E1, W100 panels for the wood finishes

③ Fronts with handle, made with MDF panels Class E1, W100 in the lacquered finishes O, B; with melamine veneered Class E1, W100 panels for the wood finishes

④ Internal structure made with melamine panels Class E1, W100 anthracite gray

⑤ Painted metal drawers with glass sides

⑥ Wall installation with adjustable wall brackets, structural bars in aluminium that can be used as an anti-release system.

- ① MEUBLE disponible en deux profondeurs: 46 cm et 53 cm.

② Côtés de finition réalisés avec panneaux de MDF Classe E1, W100, complètement laqués pour les finitions O, B, ou réalisés avec panneaux de mélamine Classe E1, W100 plaqués pour les finitions bois

③ Façades à ouverture avec poignée, réalisées avec panneaux de MDF Classe E1, dans les finitions laquées O, B; avec panneau de mélamine Classe E1, W100 plaqués pour les finitions bois

④ Structure interne réalisée avec des panneaux de mélamine Classe E1, W100 gris anthracite

⑤ Tiroirs en métal verni, avec des côtés en verre

⑥ Installation murale avec supports muraux réglables, barres structurales en aluminium qui peuvent être utilisées comme système anti-dégagement.

- ① MEUBEL verkrijgbaar in twee dieptes : 46cm en 53cm.

② Zijwanden uitgevoerd in MDF-panelen Klasse E1, W100, volledig gelakt, maar enkel in de afwerkingen O, B, in melamine-panelen in fineer Klasse E1, W100 voor de afwerkingen in hout.

③ Voorzijden met handgreep, uitgevoerd in een MDF-paneel Klasse E1 in de gelakte afwerkingen O, B; ofwel in melamine-panelen in fineer Klasse E1, W100 voor de afwerkingen in hout. In mal gemaakte handgreep in geanodiseerd aluminium, standaard geleverd in de kleur zilver cod. HS1

④ Binnenstructuur uitgevoerd in melamine-panelen in Klasse E1, W100 kleur antracietgrijs

⑤ lades in gevernist metaal met glazen tussenschotten

⑥ Installatie in de muur met regelbare wandaansluitingen, structurele stangen in aluminium die als extra ophangbeveiliging kunnen dienen.

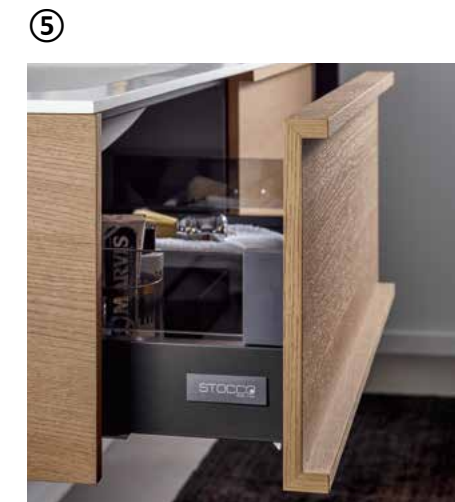

LACCATO / LACQUERED / LAQUÉ / GELAKT

CAT. O - Laccato opaco / Matt lacquered / Laqué mat / Mat gelakt

CAT. B - Laccato lucido / Glossy lacquered / Laqué brillant / Glanzend gelakt

PoppingTrend

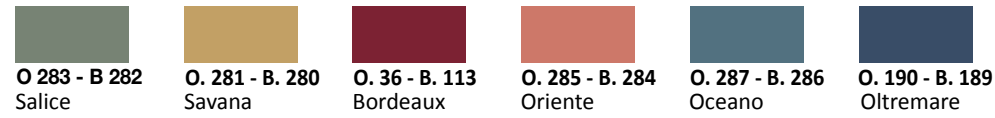

FeelingSoft

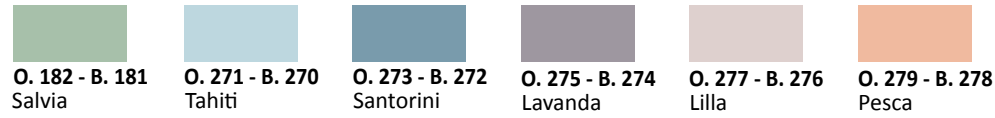

ForeverChic

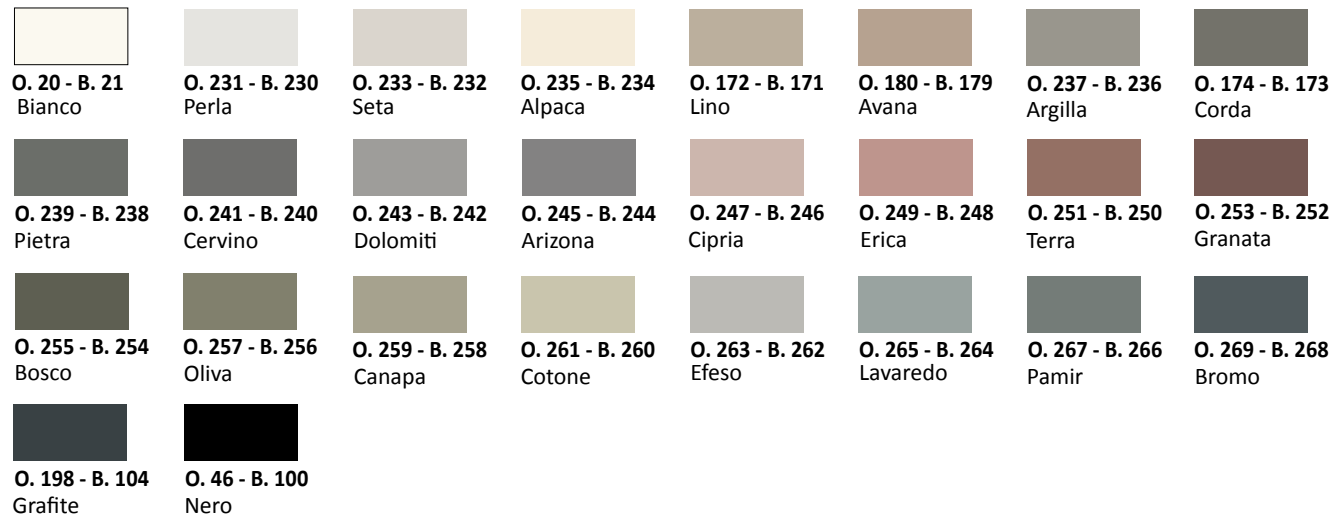

FenixLike

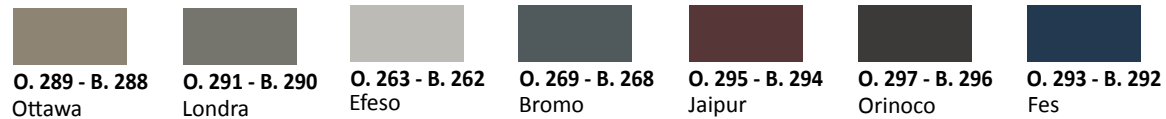

LEGNO / WOOD / BOIS / HOUT

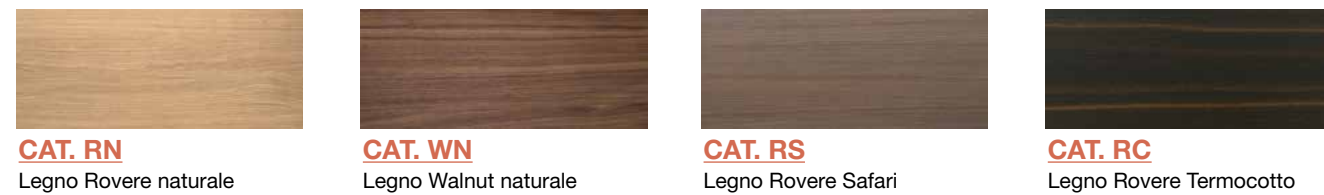

CAT. EO
Ebano opaco

CAT. EL
Ebano lucido

			L.60	L.70	L.80	L.90	L.100	L.120
H.32			•	•	•	•	•	•
H.48			•	•	•	•	•	•
H.48			•	•	•	•	•	•

		L.35	L.45	L.60	L.70	L.80	L.90
H.32		•	•	•	•	•	•
H.48		•	•	•	•	•	•
H.48		•	•	•	•	•	•

● Disponibile | Available | Disponible / Beschikbaar

Piano lavabo Loop: com'è realizzato

/ Top with integrated washbasin Loop: how it is made / Plan vasque Loop : en detail

/ Wastafelbladen Loop: hoe wordt het gemaakt

I piani lavabo sono realizzati in diversi materiali pertanto gli spessori e le tolleranze possono differire in base alla tipologia scelta.

The tops with integrated washbasin are made of different materials, therefore the thicknesses and tolerances may differ depending on the chosen type.

Les plans vasques moulés sont réalisés en différents matériaux, les épaisseurs et les tolérances peuvent donc varier en fonction du type choisi.

De geïntegreerde wastafelbladen worden in verschillende materialen uitgevoerd, en de diktes en de marges voor de afwijkingen kunnen dus verschillen al naargelang van het gekozen type.



La gamma dei piani lavabo è molto vasta. Consultare il listino prezzi Tailormade Stocco/19 per scegliere la soluzione preferita. In base alla profondità del mobile, verificare le posizioni della rubinetteria consentite per il materiale scelto.

The range of tops is very wide. Consult the price list Tailormade Stocco/19 to choose the preferred solution. Depending on the depth of the cabinet, check the positions of the allowed mixer tap holes for the chosen material

La gamme de plans vasques est très large. Consultez la liste de prix Tailormade Stocco/19 pour choisir la solution que vous préférez. En fonction de la profondeur du meuble vérifiez les positions des trous de robinetterie possibles pour le matériau choisi

Het gamma van de wastafelbladen is zeer uitgebreid. Raadpleeg de prijslijst Tailormade Stocco/19 om de oplossing van uw voorkeur te kiezen. Al naargelang de diepte van het meubel, dienen de mogelijke plaatsen van het kraanwerk voor het gekozen materiaal gecontroleerd te worden.



Piano lavabo Loop: materiali e finiture

/ Top with integrated washbasin Loop: materials and finishes / Plan vasque Loop : matériaux et finitions

/ Wastafelbladen Loop: materialen en afwerkingen

MINERALMARMO®



CAT. MMO

Mineralmarmo opaco



CAT. MML

Mineralmarmo lucido

CORIAN®

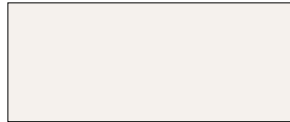

CAT. CO

Corian

HPL / HIGH PRESSURE LAMINATE

CAT. HPL



B533
White Wood



B534
Olmo



B507
Grigio Chiaro



B539
Bianco Dax Stone



B508
Portland



B546
Ossido



B500
Fossile



B545
Cesar Brown Stone

CAT. HS

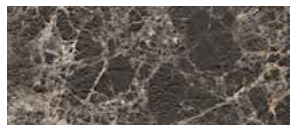

HS563
Emperador



HS424
Calacatta



HS555
Botticino



HS547
Travertino

CAT. HW



HW587
Rovere Slavonia



HW669
Rovere Primitivo

FENIX®

CAT. AF - FENIX



FX32
Bianco Kos

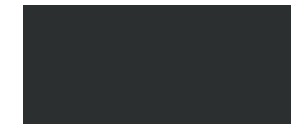

FX720
Nero Ingo

CAT. BF - FENIX COLORATO



FX717
Castoro Ottawa



FX718
Grigio Londra



FX725
Grigio Efeso



FX724
Grigio Bromo



FX751
Rosso Jaipur



FX749
Cacao Orinoco



FX754
Blu Fes



MINERALMARMO®

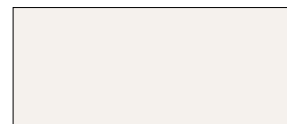

CAT. MMO

Mineralmarmo opaco



CAT. MML

Mineralmarmo lucido

CORIAN®



CAT. CO

Corian

LACCATO / LACQUERED / LAQUÉ / GELAKT

CAT. O - Laccato opaco / Matt lacquered / Laqué mat / Mat gelakt

CAT. B - Laccato lucido / Glossy lacquered / Laqué brillant / Glanzend gelakt

PoppingTrend



O. 283 - B. 282
Salice



O. 281 - B. 280
Savana



O. 36 - B. 113
Bordeaux



O. 285 - B. 284
Oriente



O. 287 - B. 286
Oceano



O. 190 - B. 189
Oltremare

FeelingSoft



O. 182 - B. 181
Salvia



O. 271 - B. 270
Tahiti



O. 273 - B. 272
Santorini



O. 275 - B. 274
Lavanda



O. 277 - B. 276
Lilla



O. 279 - B. 278
Pesca

ForeverChic

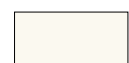

O. 20 - B. 21
Bianco



O. 231 - B. 230
Perla



O. 233 - B. 232
Seta

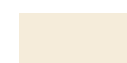

O. 235 - B. 234
Alpaca



O. 172 - B. 171
Lino



O. 180 - B. 179
Avana



O. 237 - B. 236
Argilla



O. 174 - B. 173
Corda



O. 239 - B. 238
Pietra



O. 241 - B. 240
Cervino



O. 243 - B. 242
Dolomiti



O. 245 - B. 244
Arizona



O. 247 - B. 246
Cipria



O. 249 - B. 248
Erica



O. 251 - B. 250
Terra



O. 253 - B. 252
Granata



O. 255 - B. 254
Bosco



O. 257 - B. 256
Oliva



O. 259 - B. 258
Canapa



O. 261 - B. 260
Cotone



O. 263 - B. 262
Efeso



O. 265 - B. 264
Lavaredo



O. 267 - B. 266
Pamir



O. 269 - B. 268
Bromo



O. 198 - B. 104
Grafite



O. 46 - B. 100
Nero

FenixLike



O. 289 - B. 288
Ottawa



O. 291 - B. 290
Londra



O. 263 - B. 262
Efeso



O. 269 - B. 268
Bromo



O. 295 - B. 294
Jaipur



O. 297 - B. 296
Orinoco



O. 293 - B. 292
Fes

KERLITE®

CAT. METAL KERLITE



KM01
Metal Corten nat.



KM02
Metal Iron nat.

CAT. A KERLITE



KE01
Road nat.



KE05
Cendre nat.

GRES

CAT. FG



Gres opaco / Gres matt / Gres mat / Gres mat

FG01
Bianco Statuario Venato
soft touch



FG03
Oro Venato soft touch



FG05
Nero Marquina soft touch



FG07
Noir Desir soft touch

Gres lucido / Gres glossy / Gres brillant / Gres glanzend

FG02
Bianco Statuario Venato lucidato

FG04
Oro Venato lucidato

FG06
Nero Marquina lucidato

FG08
Noir Desir lucidato

HPL

CAT. HPL



B533
White Wood



B534
Olmo



B507
Grigio Chiaro



B539
Bianco Dax Stone



B508
Portland



B546
Ossido



B500
Fossile



B545
Cesar Brown Stone

CAT. HS

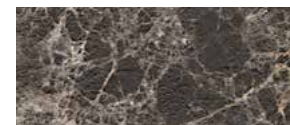

HS563
Emperador



HS424
Calacatta



HS555
Botticino



HS547
Travertino

CAT. HW



HW587
Rovere Slavonia



HW669
Rovere Primitivo

FENIX®

CAT. AF - FENIX



FX32
Bianco Kos

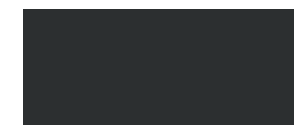

FX720
Nero Ingo

CAT. BF - FENIX COLORATO



FX717
Castoro Ottawa



FX718
Grigio Londra



FX725
Grigio Efeso



FX724
Grigio Bromo



FX751
Rosso Jaipur



FX749
Cacao Orinoco



FX754
Blu Fes

Sommario

/ Summary / Sommaire / Samenvatting

Top / Top / Plan / Wastafelblad

Lavabo / Washbasin / Vasque / Wasbekken

Mobile / Base unit / Meuble / Meubel

Specchio / Mirror / Miroir / Spiegel

Luci / Lighting / Eclairages / Verlichting

Vasca / Bathtub / Baignoire / Badkuip

Piatta doccia / Shower tray / Receveur de douche / Douchebak

Pensile / Hanging unit / Meuble haut / Hangkast

Colonna / Column / Colonne / Kolomkast

Mensolone / Top consoles / Consoles / Toplaag wastafelbladen

Dimensioni L P H cm / Sizes / Dimensions / Afmetingen



Pag. 34 - 41

Loop 53 - Comp.06

Lavabo Ceramilux Baia BT60_F41

Top Gres Nero Marquina FG05

L 166,8 P 53 H 0,5

Mobile Legno Rovere Termocotto RC

L 166,8 P 53 H 48

Specchio BS7100TL L 100 H 70

Pensile Loop RC L 60 P 15 H 25



Pag. 42 - 43

Loop 46 - Comp.07

Top Mineralmarmo

L 123,4 P 46 H 1,5

Mobile Santorini B. 272

L 123,4 P 46 H 48



Pag. 44 - 47

Loop 46 - Comp.08

Lavabo Ceramilux Baia BT100_F41

L 100,1 P 46 H 10

Mobile Londra O.291, Rovere naturale RN

L 100,1 P 46 H 48

Specchio BS7100LL

L 100 H 70

Vasca Mineralmarmo Iris

L 165 P 65 H 55



Pag. 6 - 13

Loop 46 - Comp.01

Lavabo Loop Ceramilux BE400

Top Gres Oro Venato Soft Touch FG03

L 241,8 P 46 H 0,5

Mobile Legno Rovere Termocotto RC

L 241,8 P 46 H 48

Specchio

L 120 H 100

Pensile Loop RC L 120 P 15 H 25

Colonne Loop RC L 66 P 25 H 170



Pag. 14 - 15

Colonne Loop Lino O.172

L 132 P 170 H 25

Vasca Origami Round L 170 P 80 H 50



Pag. 16 - 19

Loop 46 - Comp.02

Lavabo Loop Ceramilux BE400

Top Gres Nero Marquina FG05

L 138,4 P 46 H 0,5

Mobile Walnut WN

L 138,4 P 46 H 32

Specchio Charm Ø 80



Pag. 48 - 49

Loop 46 - Comp.09

Lavabo Ceramilux Baia BT120_F41

L 119,8 P 46 H 10

Mobile Legno Rovere Safari RS

L 119,8 P 46 H 48



Pag. 50 - 55

Loop 46 - Comp.10

Lavabo Ceramilux Loop BE400

Top Gres Oro Venato FG03

L 140 P 51,5 H 8

Top Gres Oro Venato FG03

L 143,4 P 46 H 0,5

Mobile Legno Termocotto RC

L 143,4 P 46 H 32

Specchio BS70140 L 70 H 140

Lampada BL64P



Pag. 56 - 57

Loop 46 - Comp.11

Lavabo Ceramilux Loop BE400

Top Gres Oro Venato FG03

L 143,4 P 46 H 32

Mobile Legno Rovere Termocotto RC

L 143,4 P 46 H 32

Specchio BS70140

L 70 H 140



Pag. 20 - 27

Loop 46 - Comp.03

Top Corian

L 153,4 P 46 H 1,2

Mobile Ebano EO L 153,4 P 46 H 32

Specchio Frame

L 140 H 70

Colonna Loop EO L 66 P 25 H 170



Pag. 28 - 31

Loop 53 - Comp.04

Top Corian L 190,1 P 53 H 1,2

Mobile Rovere Safari RS, Granata

O.253 L 190,1 P 53 H 32

Colonne Loop Rovere Safari RS

L 25 P 15 H 150

Specchio Charm Ø 80



Pag. 32 - 33

Loop 46 - Comp.05

Lavabo Loop Ceramilux BE400

Top Corian L 241,8 P 46 H 1,2

Mobile Walnut WN L 241,8 P 46 H 32

Specchio L 150 H 110

Colonne Loop Walnut WN

L 132 P 25 H 170



Pag. 58 - 59

Loop 53 - Comp.12

Lavabo Ceramilux Loop BE400

Top Corian

L 109,8 P 53 H 1,2

Mobile Legno Walnut WN, Bianco O.20

L 109,8 P 53 H 32

Specchio BS780TL L 80 H 70

Tailormade Stocco Collections

all rights reserved Community Design

Graphic Design

Stocco LAB

Product Design

R&D Stocco

AD/Copy

Lorenza Prandina

Printing

Grafiche Antiga

Thanks to



TAILORMADE
STOCCO

F.lli STOCCO srl

Via Valsugana, 318/A

35010 - S. Giorgio in Bosco (Padova) Italy

tel. +39 049 9453911

commerciale@stocco.it

www.stocco.it

Mineralmarmo®, Ceramilux®, Corian®, Kerlite®, Fenix®, Laminam® sono marchi registrati di proprietà dei loro rispettivi titolari.

Mineralmarmo®, Ceramilux®, Corian®, Kerlite®, Fenix®, Laminam® are registered trademarks owned by their respective owners.

Mineralmarmo®, Ceramilux®, Corian®, Kerlite®, Fenix®, Laminam® sont des marques déposées appartenant à leurs propriétaires respectifs.

Mineralmarmo®, Ceramilux®, Corian®, Kerlite®, Fenix®, Laminam® zijn geregistreerde handelsmerken en zijn eigendom van de respectieve houders ervan.

Loop_01/2021_IT - EN - FR - NL

F.lli Stocco srl ha facoltà di apportare ai prodotti tutte le modifiche, migliorie tecniche ed annullamenti di articoli di fine serie che siano ritenuti opportuni, in qualsiasi momento, senza alcun preavviso.

F.lli Stocco srl è azienda certificata per il sistema sicurezza OHSAS18001.

F.lli Stocco srl reserves the right to introduce changes, technical improvements and cancellations of not available articles, that are considered necessary, at any time, without any prior notification.

F.lli Stocco srl is a certified company for the OHSAS18001 safety system.

F.lli Stocco srl se réserve d'apporter, en n'importe quel moment, des modifications aux produits, améliorations techniques et annulations pour articles de fin de série, qui seront considérées opportunes, en ne donnant aucune communication anticipée de cela au client.

F.lli Stocco srl est une entreprise certifiée pour le système de sécurité OHSAS18001.

F.lli Stocco srl behoudt zich het recht voor alle aanpassingen, technische verbeteringen en stopzetting van einde reeks-producten te doen die het nodig acht, op om het even welk moment, zonder enige voorafgaandelijke waarschuwing.

F.lli Stocco srl is een gecertificeerd bedrijf voor het veiligheidssysteem OHSAS18001.



